

# EMBRACE CEILING SHOWERS

## INSTALLATION INSTRUCTIONS

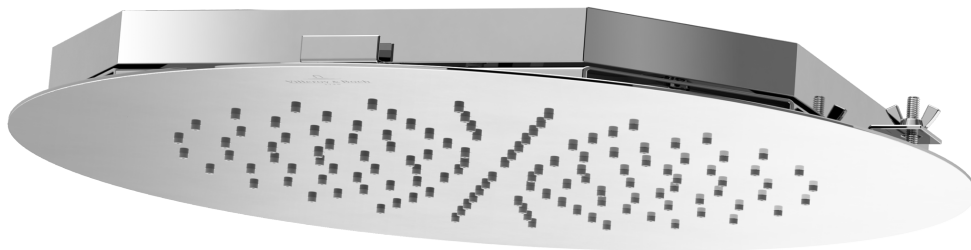

VSC80380B  
EMBRACE 380 ROUND CEILING  
MOUNTED SHOWER



VSC70350B  
EMBRACE 350 SQUARE CEILING  
MOUNTED SHOWER

## NOTES PRIOR TO INSTALLATION

1. Important: Shower installation frame needs to be installed prior to sheeting ceiling.
2. Shower frame installation noggings and battens to be installed in desired shower location.
3. Support noggings & battens should be installed 20mm back from finished ceiling face.
4. Ensure water point is located adjacent to shower location.
5. Inspect all parts prior to installation for suitability and / or defects.
6. Any suspected defect should be reported as soon as possible.
7. Should any products be installed despite a fault having been found and reported, Argent will not accept liability for the cost of labour to remove and install any replacement product/s.

## PRESSURE AND TEMPERATURE REQUIREMENTS

1

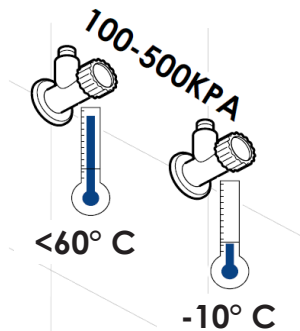
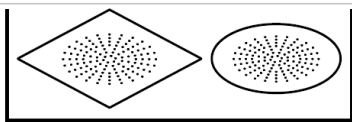

### IMPORTANT

- 1 Inlet pressure range 100 - 500kpa
- 2 Maximum hot water temperature 60 C
- 3 AS / NZS 3500 requires 500 kpa maximum operating pressure at any outlet within a building

## PRE CEILING INSTALLATION ROUGH IN

2

Nogging and Batten set out.

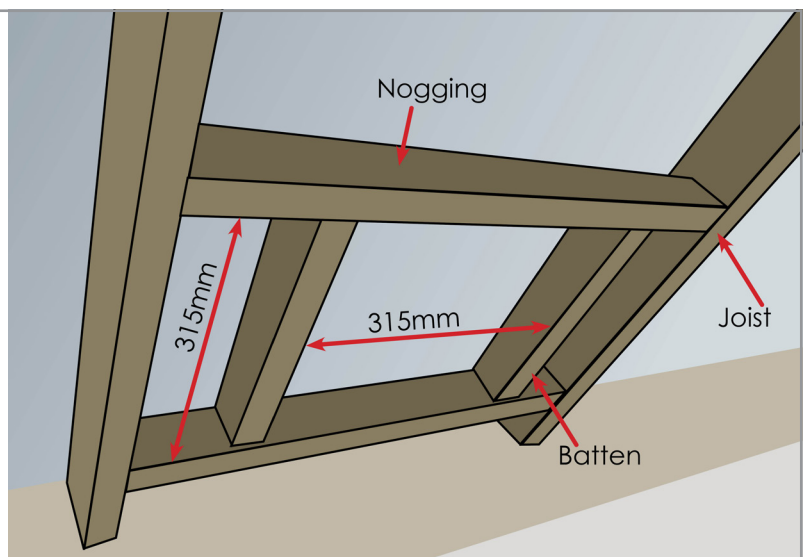

**3**

Noggings and battens to be installed 20mm back from finished ceiling face.

i.e. rebated 10mm back from joist face when using 10mm gyprock.

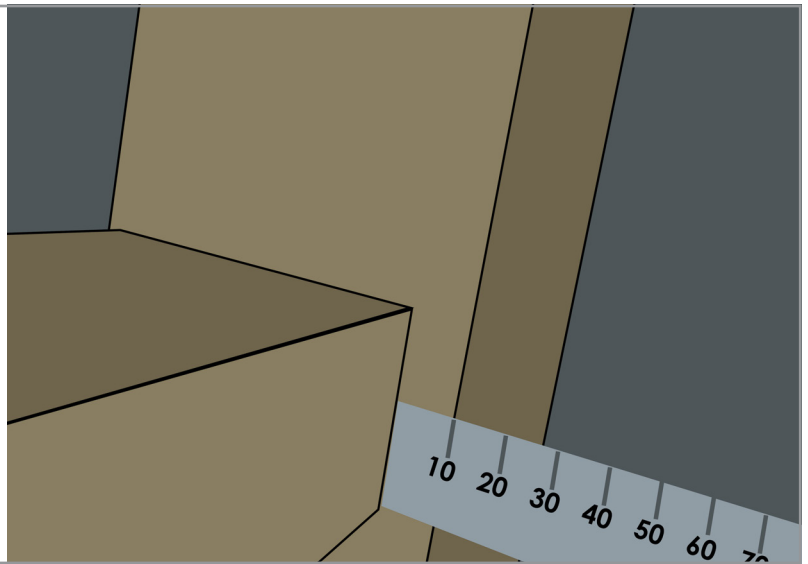

**4**

install the shower installation frame onto the rebated battens/noggings with the Stainless Steel pan head screws provided.

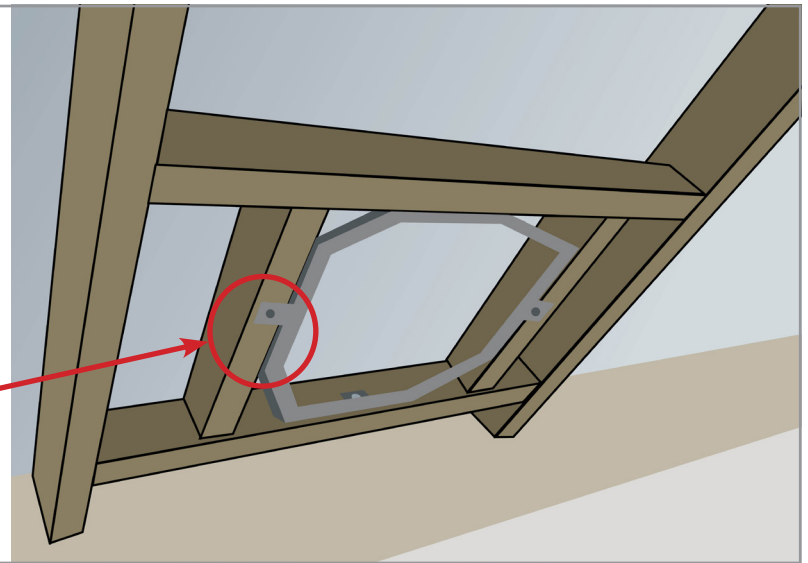
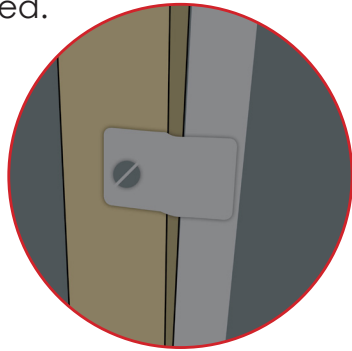

## POST CEILING INSTALLATION

**5**

Use the template provided to trim the ceiling sheeting to the outside of the installed shower support frame.

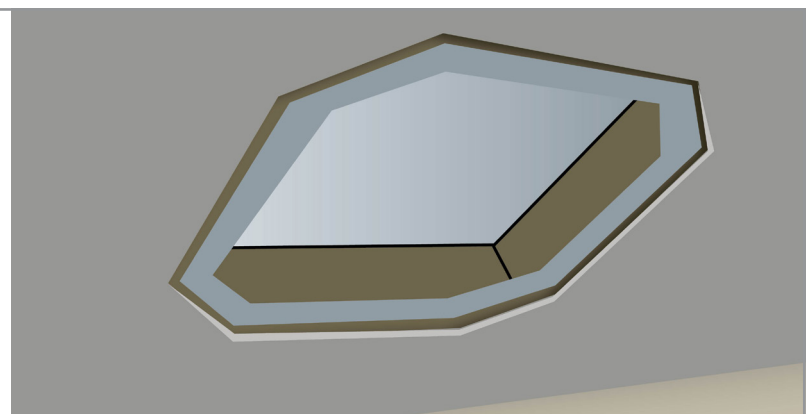

**6**

Ensure any cut ceiling material is sealed to prevent damage by steam or water ingress.

The ceiling is now ready for painting.

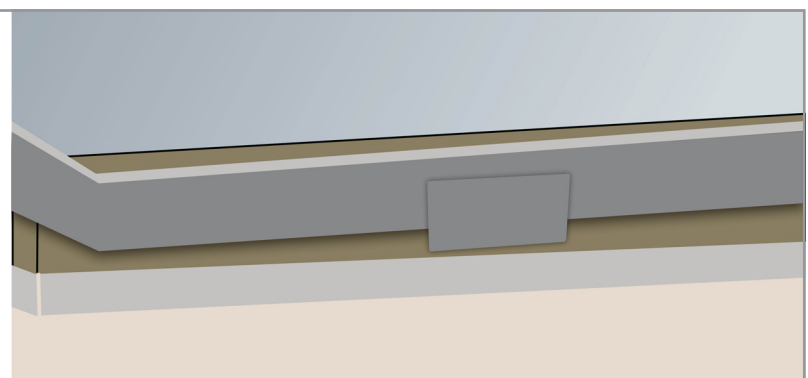

## FIT OFF

7

- Adjust shower head support bolts so they are flush with the finished ceiling face.
- Test fit shower head to ensure the fit to the ceiling (adjust if required)
- Tighten lock nuts to lock shower head support bolts in place.

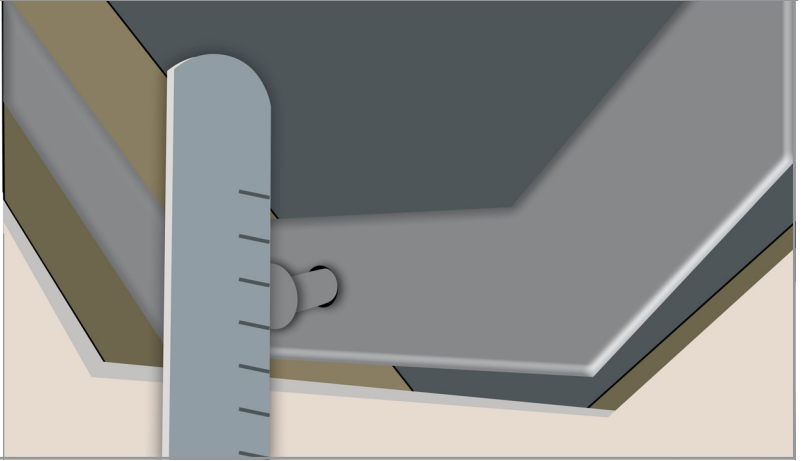

8

- Connect the shower head to the water supply with an approved flexible connection.
- Test to ensure there are no leaks prior to final installation.

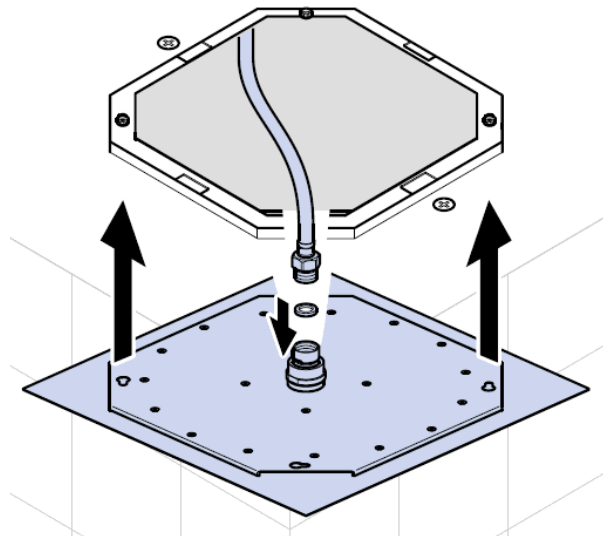

9

Align shower head with support frame and lock into place (small turn anti-clockwise).

