



Advantage 600 Grab Rail

Matte Black

Product Image



Product Details

Code:	428860MB
Brand:	Argent
Range:	Advantage
Warranty:	5 Years*
WELS:	N/A

Additional Features

Required Product

Recommended Products

Additional Notes

- AdvantageSeal Flange
- Manufactured From 304 SS

Installation Instructions

* Grab Rails to be installed to AS1428.1-2009 & AS3500 compliance requirements

Technical Specification

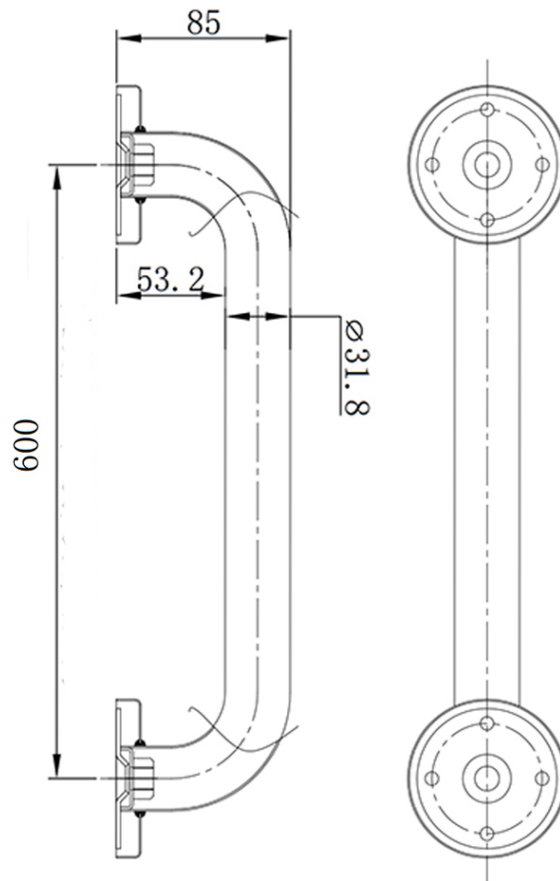

*Please visit argentaust.com.au/warranty to view the full warranty

Note: All dimensions are in millimetres and are subject to normal manufacturing variations. Always use the physical product measurements for cut-outs and rough-ins as the technical details shown may differ from the actual product. Use acetic cured silicone sealant. Do not use epoxy type adhesives. Clean with damp cloth. Do not use abrasive cleaners, liquids or pastes.

